

# STAND ASSEMBLY GUIDE

Package includes:



#A Column (1)



#B Dispenser (1)



#C Base Plate (1)



#D Bolt (1)



#E Screw (4)



#F Small Locking Washer (4)



#G Large Locking Washer (1)



#H Butterfly Nut (4)

**\*When attaching pieces\***

**\*Tighten gently Do not Force\***

## Step 1

Attach #A Column to #C base plate #D Bolt #G Large locking washer

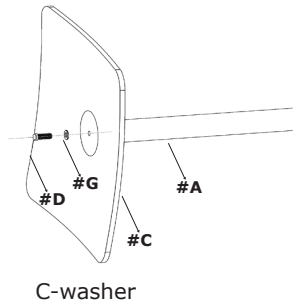

## Step 2

Open #B dispenser with the key provided or any flat object

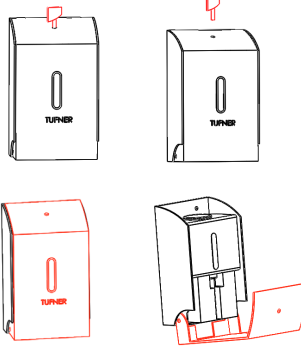

## Step 3

Remove the reservoir from #B dispenser

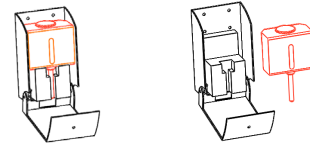

To install batteries (not included): push up on battery cover to open. Requires 4 C batteries

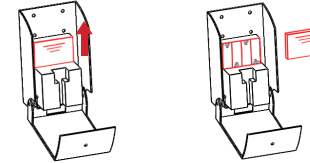

For detailed initial setup of the dispenser, please refer to the manual inside the dispenser package

## Step 4

Install #B dispenser on #A column via #E screws, #F small locking washer, and #H butterfly nuts



**\*Tighten gently\***  
**\*Do not Force\***

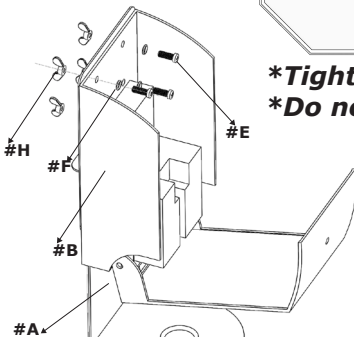

## Step 5

Put the reservoir back into the #B dispenser and close the front side

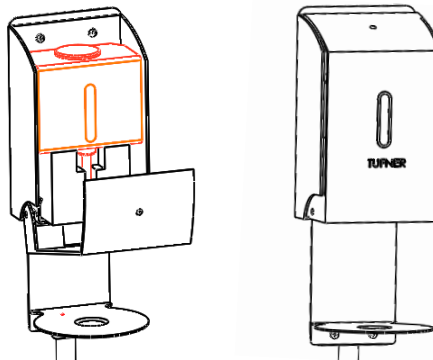

## Step 6

Dispenser stand completed

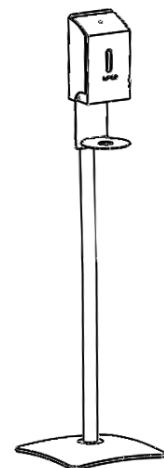

**TUFNER INC.**

**HEADQUARTERS**  
9030 BRIDGEPORT PLACE RANCHO CUCAMONGA, CA 91730  
**MANUFACTURING FACILITY**  
1800-1900 NORTH COLLINS FWY. HOWE, TX 75459

**888.688.4833**  
**SALES@TUFNER.COM**  
**WWW.TUFNER.COM**